

ACTIVE DEBRIS REMOVAL MISSION WITH SMALL SATELLITE

Marcello Valdatta

Niccolò Bellini

Davide Rastelli

University of Bologna, ITALY

2nd Mission Idea Contest

4th Nano-satellite Symposium on October 10th - 13th , Nagoya

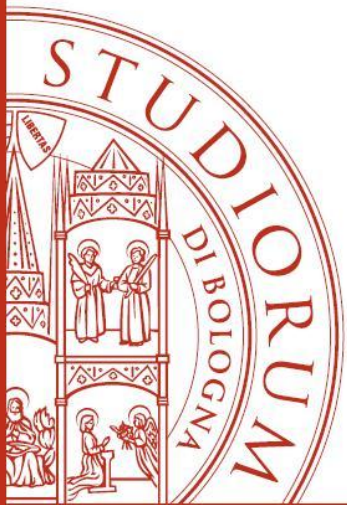

1. INTRODUCTION (1/2)

SPACE DEBRIS: an increasing problem...

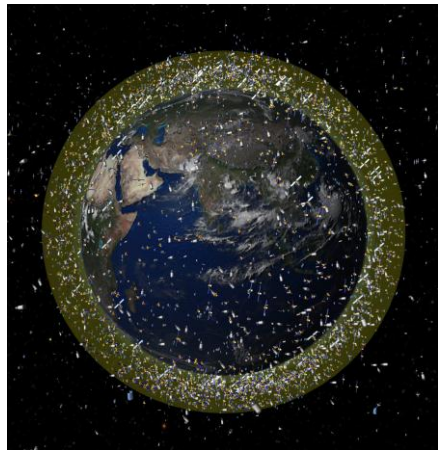

6000 satellites **launched** from 1957 and 2008,
but only about **800** are actually **operational**

Space junk includes space hardware and fragments of
broken up, exploded, collided or abandoned spacecrafts

More than **12 000** in total are regularly **tracked**

Collision IRIDIUM 33 – COSMOS 2251

1st

ER

Prevision of the first collision in
2009!!

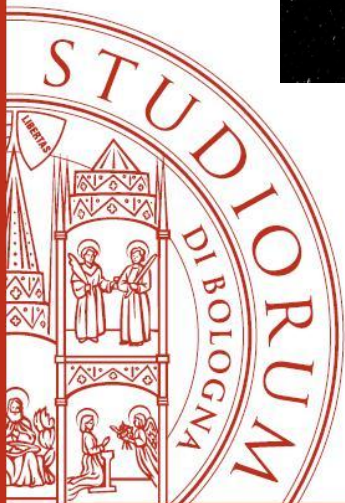

1. INTRODUCTION (2/2)

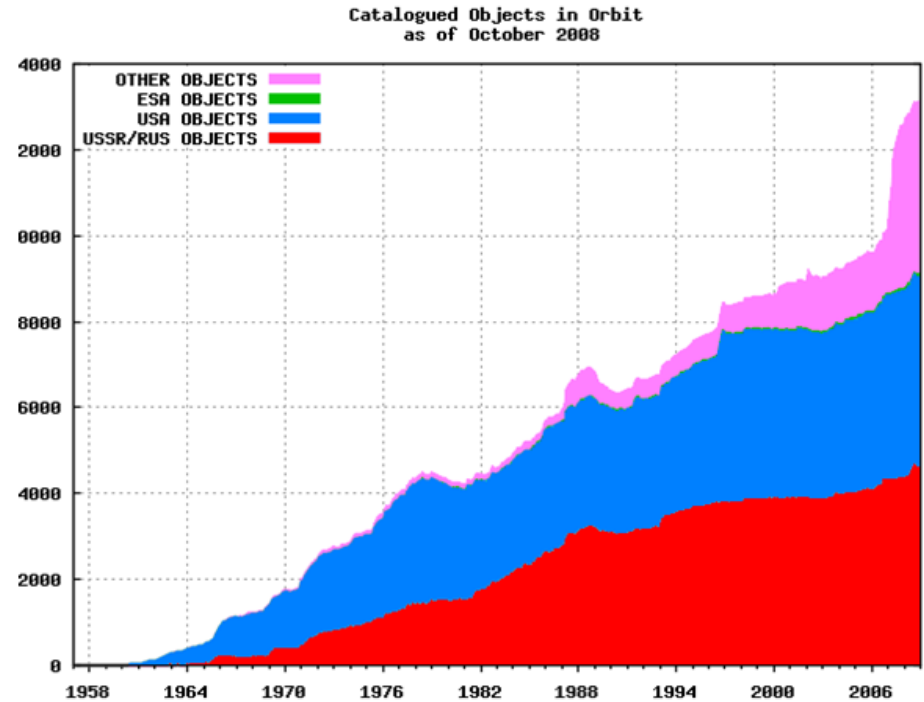
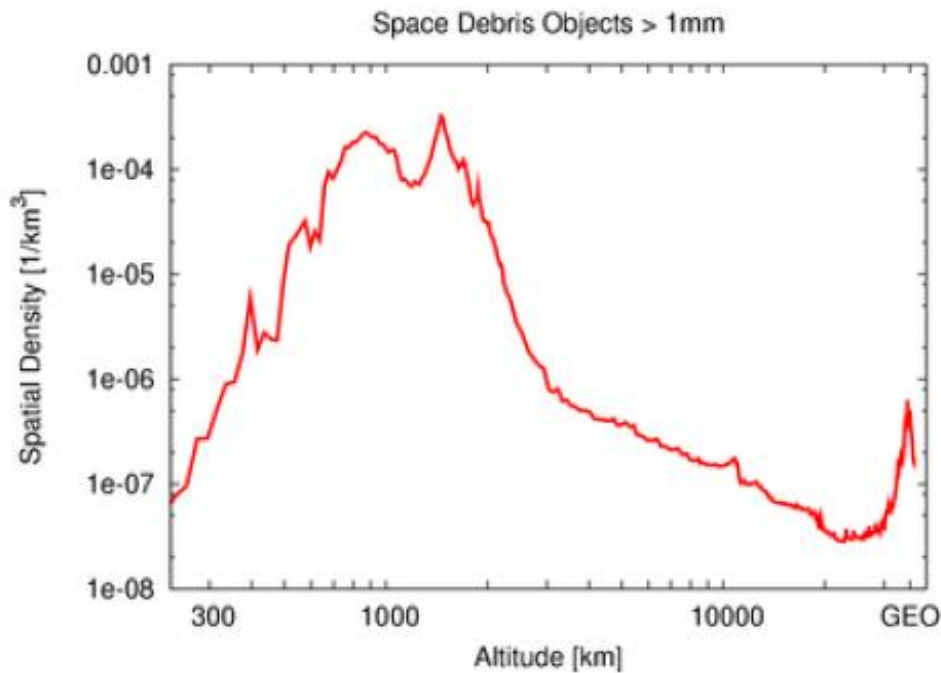

Most of them are in LEO!

1 collision
every **4** years!

+ 75%
of population growth in
the next 200 ys!

Controlling the growth of future Leo debris populations with ADR; Liou, Johnson, Hill - 2009

1. INTRODUCTION (2/2)

Why an ADR mission?

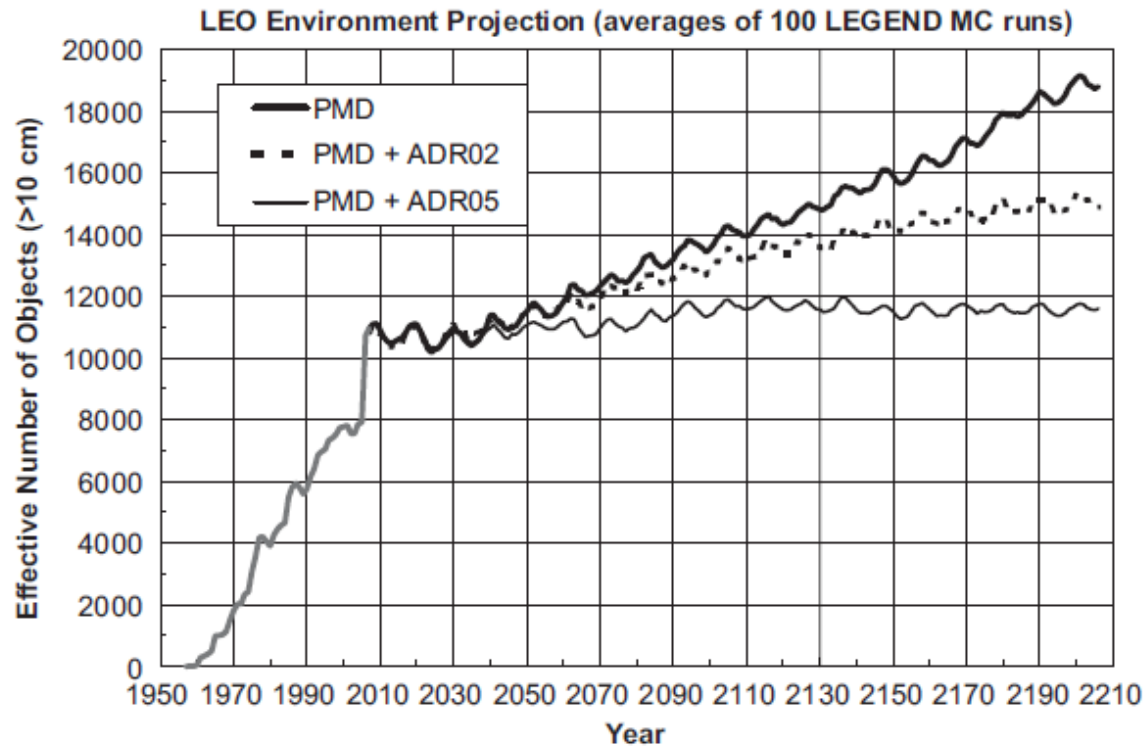

5 debris/yr

**Population
growth stops!**

ADR is the only option to preserve the future Earth **environment**

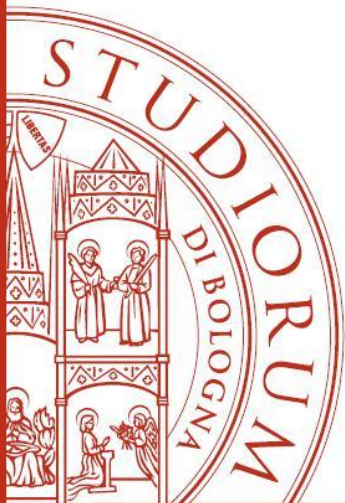

2. MISSION OBJECTIVES (1/5)



Polyurethane foam

Polyol and Isocyanate react together,
expanding more than 20 times their volume
and creating a rigid foam

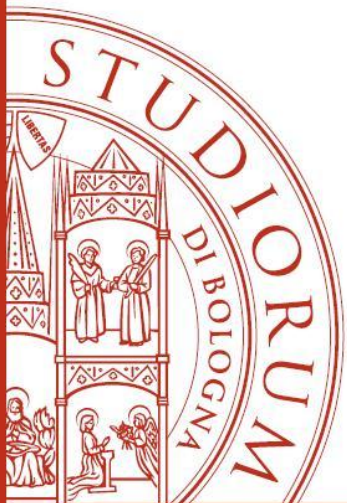

2. MISSION OBJECTIVES (2/5)

The IDEA...

Use the expansion of the foam to increase the wet surface of the debris



Increase of atmospheric **DRAG** and faster deorbiting

Before....



...After

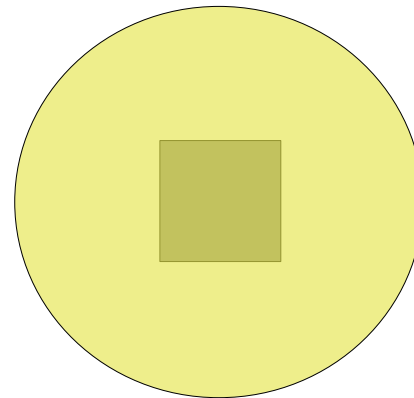

Re-entry time:

from **>100 yr**

to **<20yr**

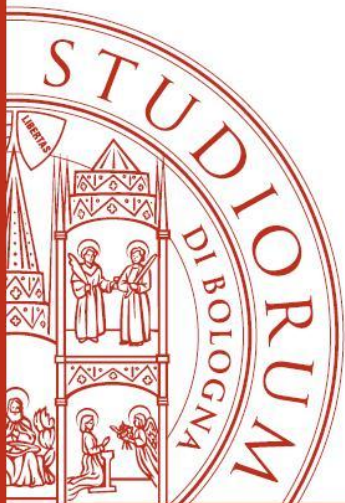

2. MISSION OBJECTIVES (3/5)

How to attach the foam to the debris?

satellite with a device (ADR SYSTEM) that mix the components and shoot the foam against

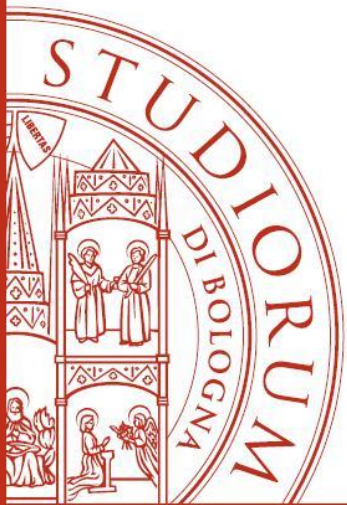

2. MISSION OBJECTIVES (4/5)

Same satellite architecture and devices, but different chemical foam comp



NOT CONTROLLED REMOVAL

Advantages:

- Lower cost
- Less risks of ADR failure due to lower density of the foam
- Possibility of removing multiple debris with one mission (More ADR sys)

Disadvantages:

- Slow mitigation: debris deorbiting is due to atmospheric drag and re-entry time depends on the orbit and the mass.

$$B = c_d \frac{A}{m}$$

$$(t_f - t_0) = \frac{H}{B \sqrt{\mu r}} \frac{1}{\rho(r_0)}$$

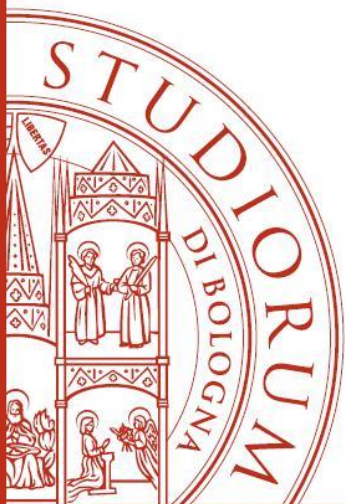

2. MISSION OBJECTIVES (5/5)

- 1) Removal of a specific debris properly identified
- 2) Qualification of a new deorbiting system for nanosatellite
- 3) Qualification of a new concept for cubesat/nanosatellite structure

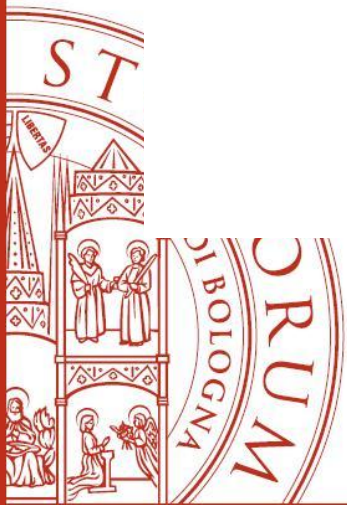

3. CONCEPT OF OPERATION (1/2)

Debris Identification:

Norad n°33856 - Iridium 33 debris



DEBRIS ORBIT

Altitude: 705 x 741 Km

Inclination: 86.32 deg

RAAN: 296.43

Mean Anomaly: 308.256

Perigee argument: 52.092

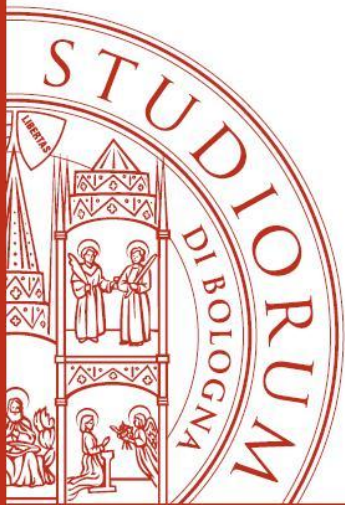

Ground segment:

Kiruna station

Easiest access to polar orbit to perform con

3. CONCEPT OF OPERATION (2/2)

Deployment of deorbiting system:

Extractable sails are deployed increasing A/m ratio of the cubesat and causing it to deorbit

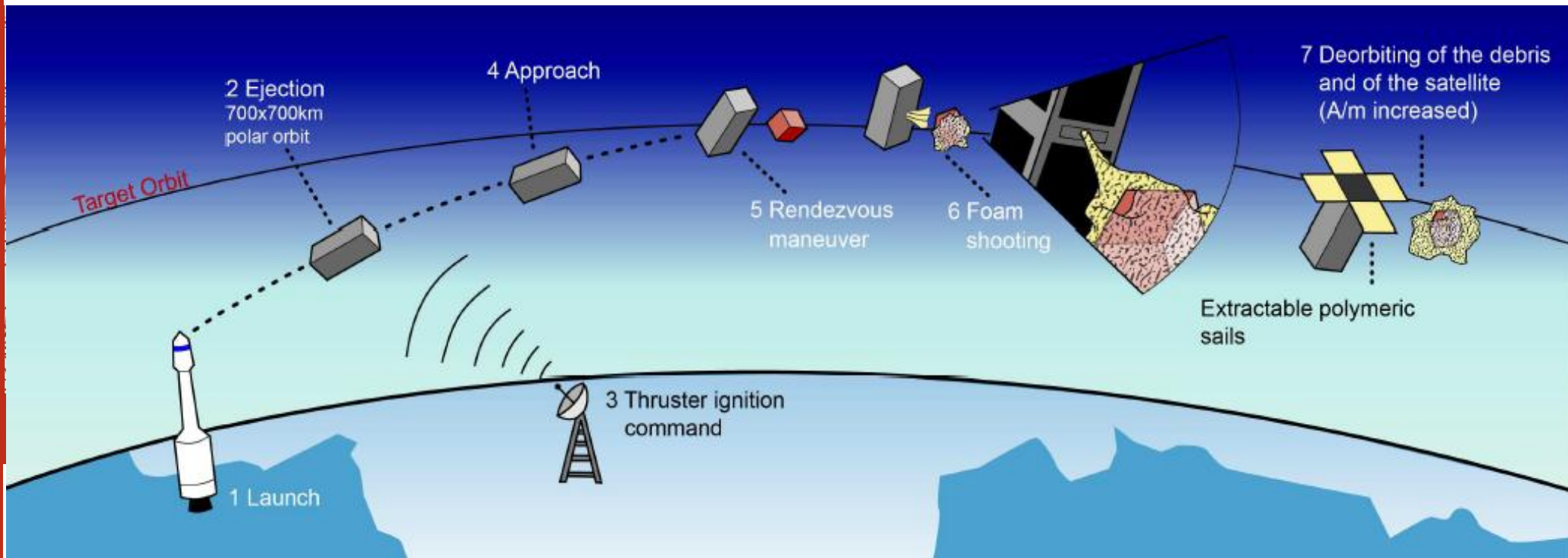

4. KEY PERFORMANCE PARAMETERS (1/4)

PERFORMANCE ANALYSIS

Project data:

- Components stored Volume: **67152 mm³**
- Nominal expansion ratio: **30**
- Debris size: **100x100x100 mm - 1 kg**
- Starting A/m: **0.01**

Ipothesis:

- Foam assumes a spherical shape once is formed
- Final volume: **2.014 mm³**
- Added wet surface: **4.08 dm²**

-Absence of gravity

-No constraints

-Omnidirectional expansion

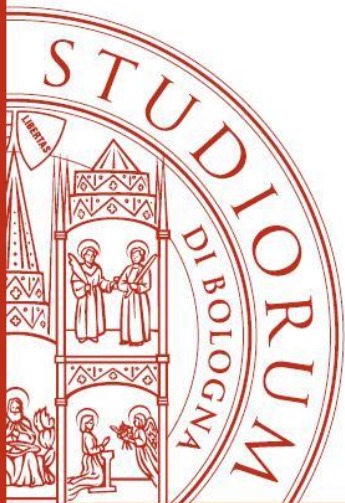

4. KEY PERFORMANCE PARAMETERS (2/4)

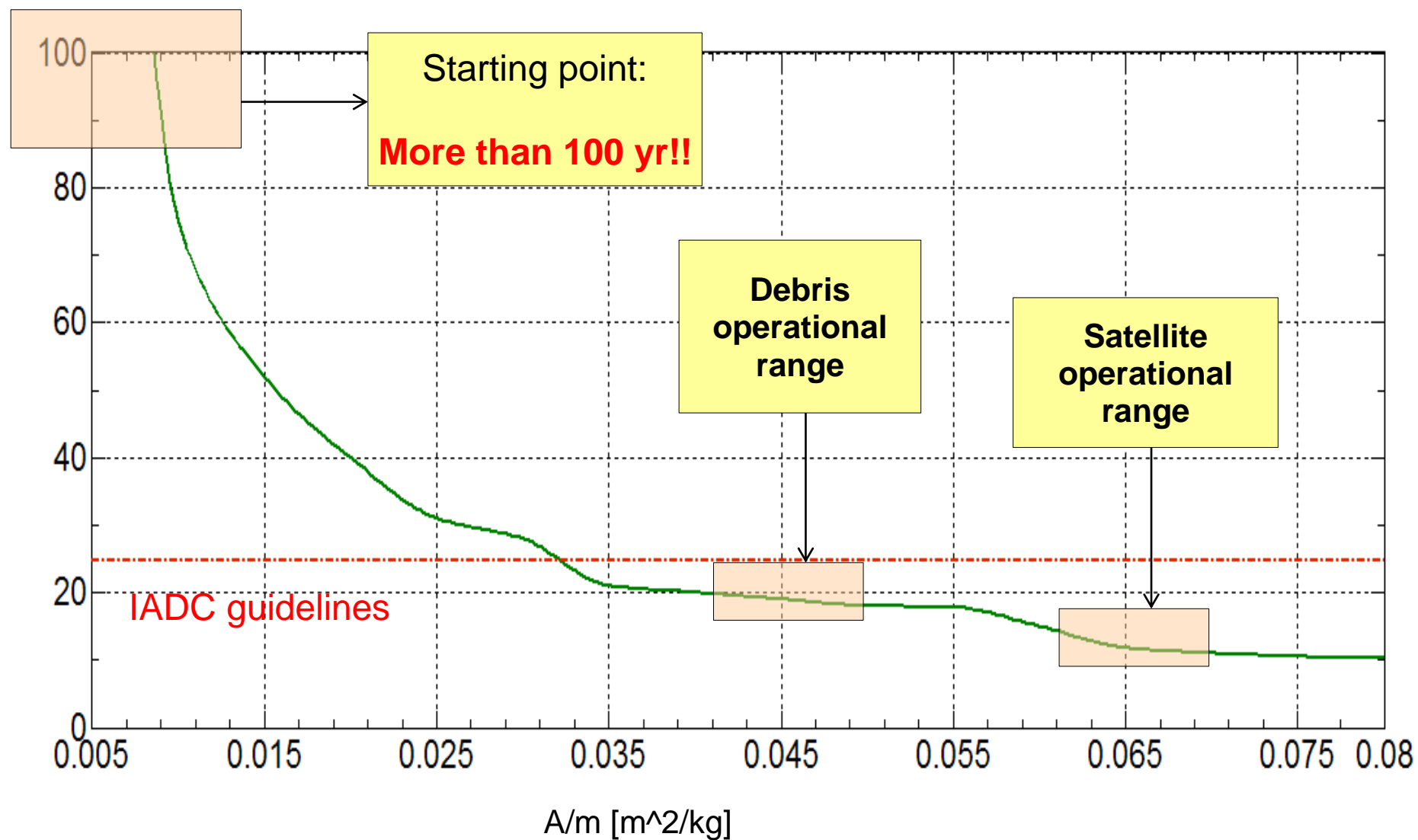

Orbit lifetime [yr]

4. KEY PERFORMANCE PARAMETERS (3/4)

Orbit lifetime of the debris reduced more than **80%**

Deorbiting of cleaner satellite respects IADC guidelines

Vacuum space INCREASES expansion ratio over the nominal value

Performance could be better !!

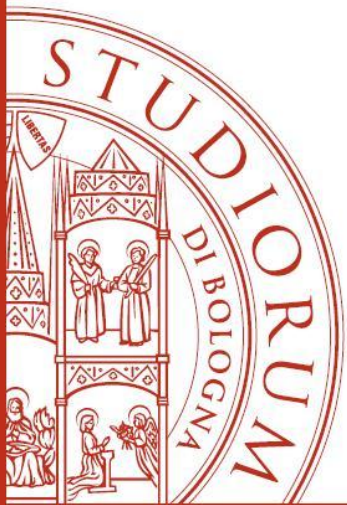

4. KEY PERFORMANCE PARAMETERS (4/4)

Functional Parameters Table

F1	The Satellite should be in the same orbit of the debris
F2	The ADR System should be in condition to catch the debris
F3	The foam has to catch the debris
F4	The deorbiting system has to increase exposed surface

Performance Parameters Table

P11	Satellite has to be injected by the launcher in the same orbit of the debris
P12	Accurate tracking of the debris and its orbit
P21	The distance between satellite and debris has to be <20 cm
P22	The attitude of the satellite has to be corrected in order to hit the debris with the foam
P31	Temperatures of the reagents shall be adequate (40 – 60°C as a range, 50°C the optimal T), in order to make the reaction occurring properly
P32	The system has to eject the fluids
P41	The drag sail has to be deployed

5. SPACE SEGMENT (1/12)

SPACE SEGMENT					
Component	Description/Function	Mass [g]	Power [W]	Dimension [mm]	Cost
Structure	ABS 3U cubesat	200	-	100x100x300	Developed by students with free spare parts
ADR system	Catcher device based on polymeric foam.	600	-	100x50x30	Developed by students with free spare parts supplied by interested enterprise
Deorbiting system	Deployable sails	200	-	100x100x10	Developed by students with free spare parts
Power system	2x6 NiMh battery 12 triple junction solar panel	2x360 100	-	50x100x30 100x100x1	8000 €
Attitude control & determination	Magnetorquer and reaction wheels, solar sensor	250	0.5	45x45x10	10000 €
Propulsion system	ION Electropray Thruster	950	5.00	96x96x70	20000 €
Proximity determination sys	Camera ad sensors	50	0.16	10x9x7.34	2000 €
PCB	SRL specific design	80	0.04	85x83x18	800 €
TX/RX	VHF downlink/UHF uplink/ S-band	100	0.15	-	10000 €
Thermal system	Flexible thermal heater for foam components.	-	4.00	-	100 €
TOTAL		3.250 Kg	-	-	50900 € (without launch)

5. SPACE SEGMENT (2/12)

POWER SYSTEM	
Average Power	1.64 W
Peak Power	5 W (During Rendezvous maneuver)
Battery Pack 1 Power	0.55 A/h @ 7.2 V
Battery Pack 2 Power	0.55 A/h @ 7.2 V
Solar Panels	~0.50 A @ 5 V

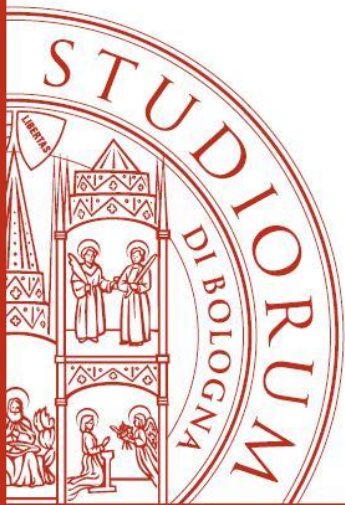

5. SPACE SEGMENT (3/12)

Structure

- Plastic material: ABS
- Rapid prototyping technique

- ➔ Addition of material layer by layer
- ➔ FDM: fused deposition modelling
- ➔ Optimization of the useful volume
- ➔ Short time of manufacturing and low costs

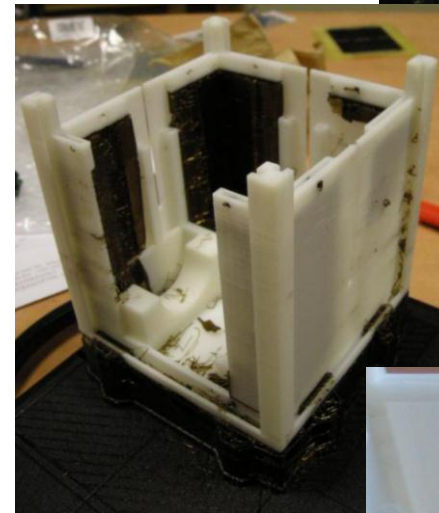
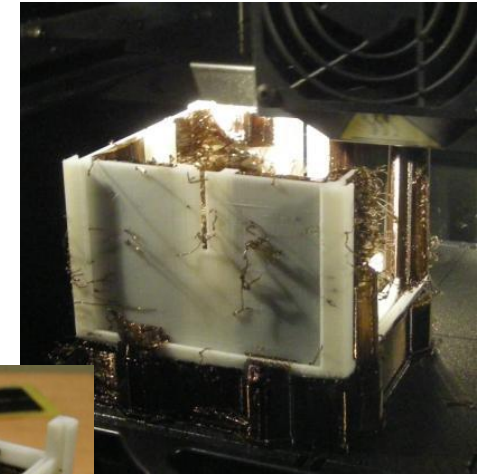

5. SPACE SEGMENT (4/12)

Advantages:

- Possibility to create very complex shapes
- Easy customization of inner and external details
- Lighter structure
- Short time of manufacturing

LOWER COSTS!!

Disadvantages:

- Lower mechanical properties than aluminum
- Not isotropic item
- Impossibility to thread the material

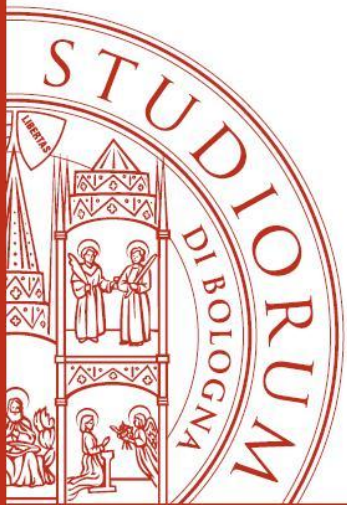

5. SPACE SEGMENT (5/12)

Deorbiting system:

Based on 4 deployable poliurethane foam sails

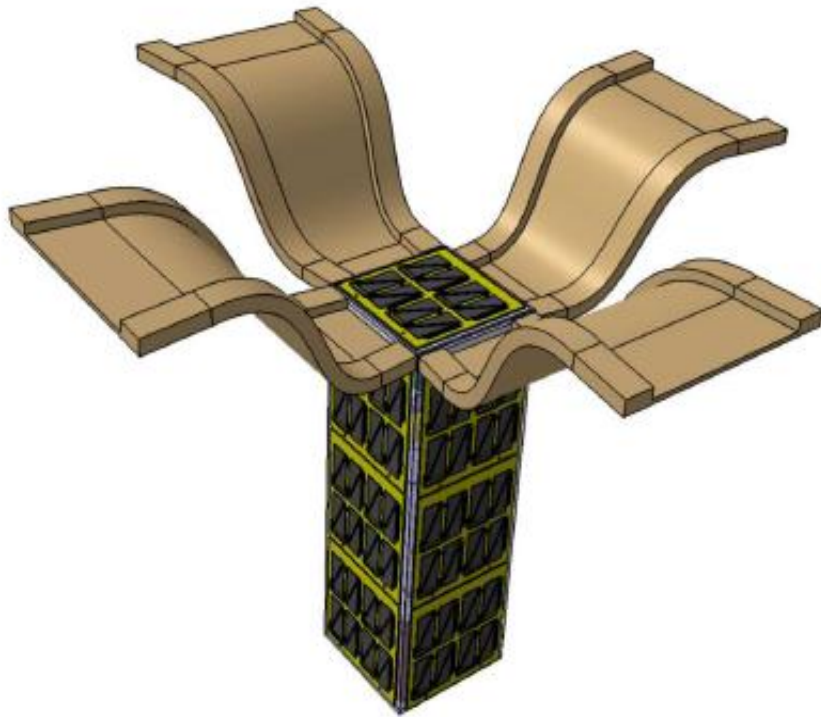

- Designed to stabilize and keep the core
- A/m ratio increased up to
- 0.05 m²/kg
- Low storage volume (~ 7% of a 3U cube)

5. SPACE SEGMENT (6/12)

ADR System

- Fluids are forced together in a static

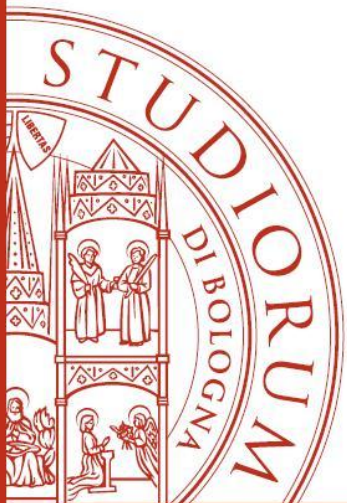
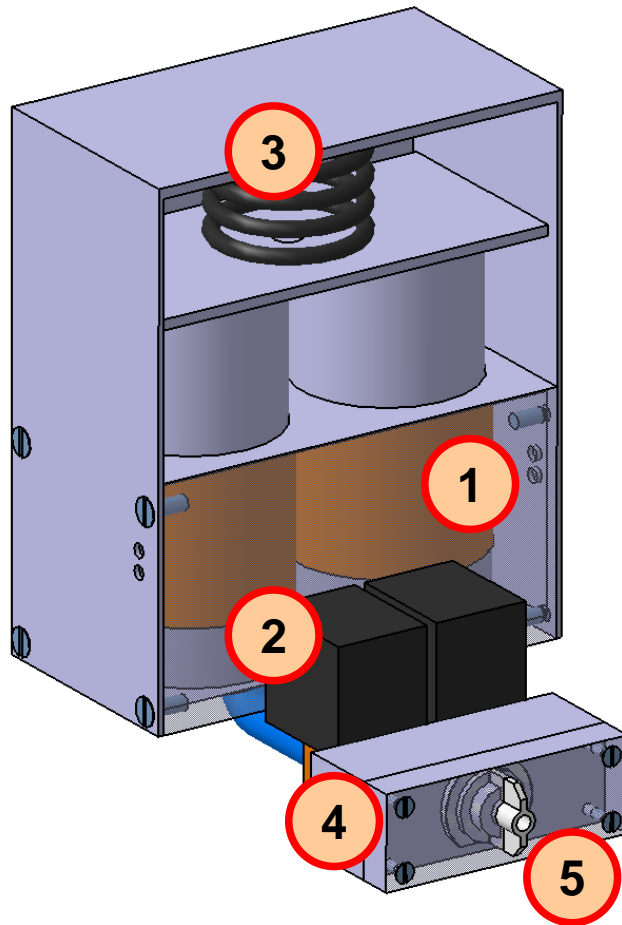

5. SPACE SEGMENT (7/12)

The architecture of ADR system is based on t

series

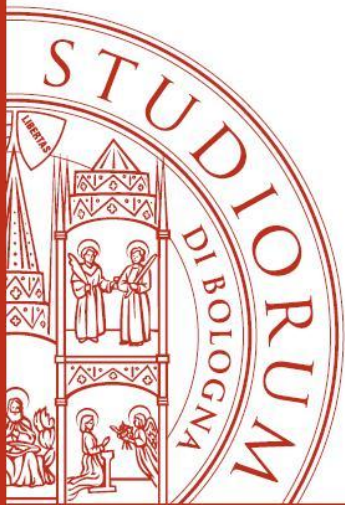
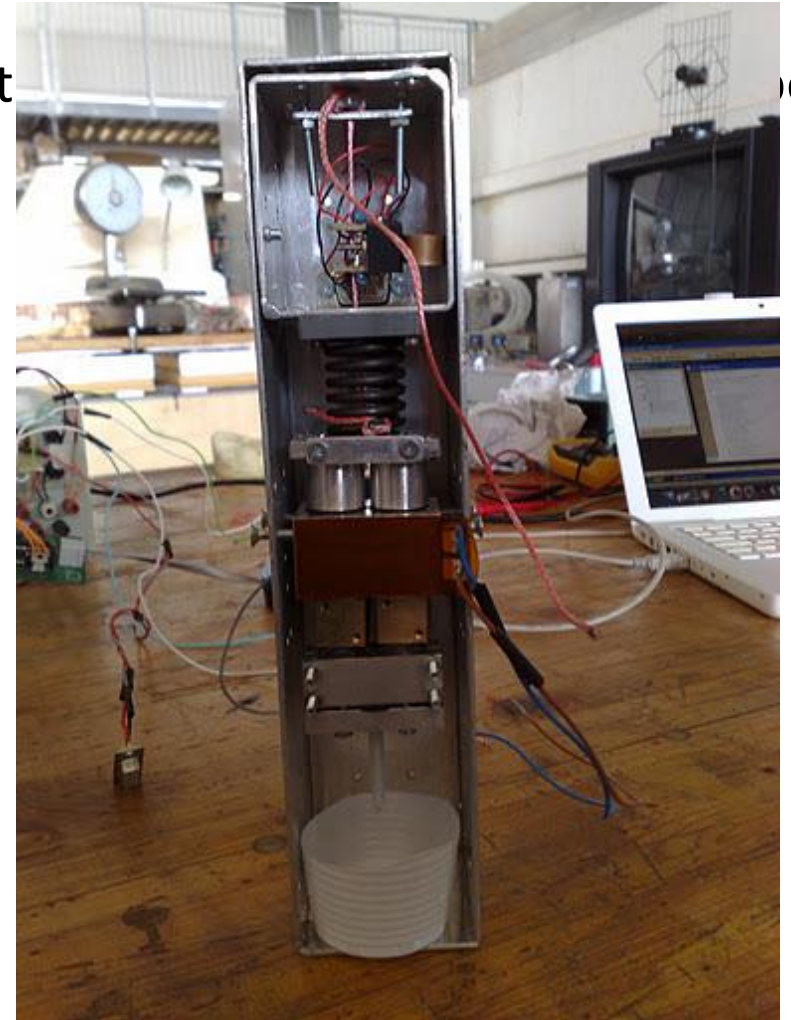
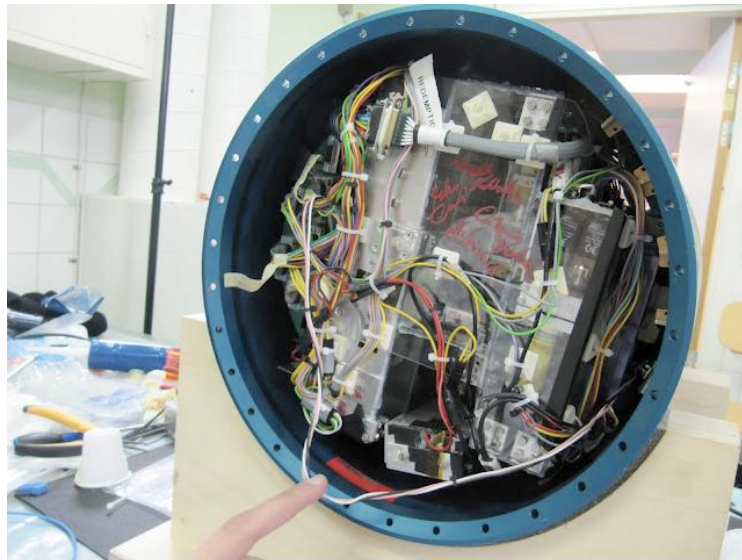

5. SPACE SEGMENT (8/12)

In vacuum condition has been registred an over expansion!

PADUA University & DUNA Corradini Group facilities

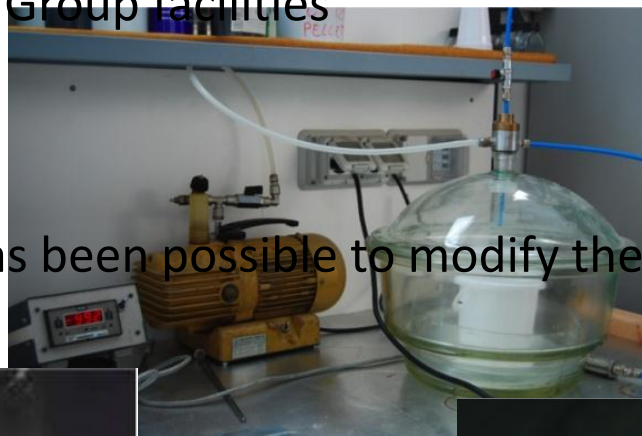
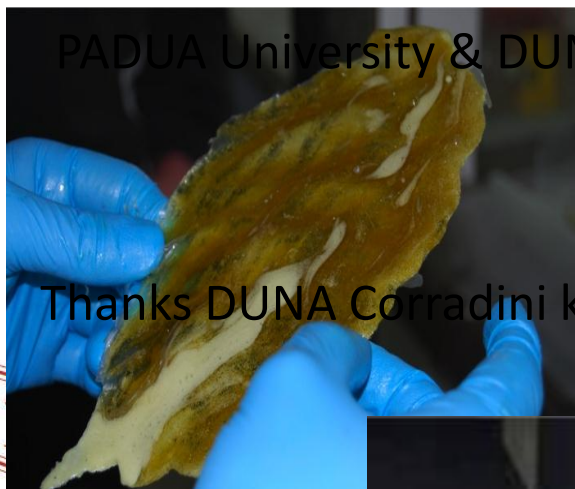

Thanks DUNA Corradini know-how has been possible to modify the chemical composition

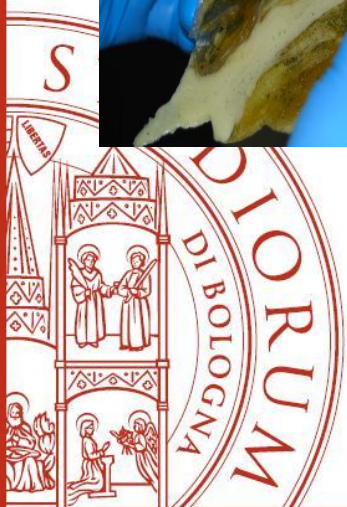

 CURTI

 N.P.C.
New Production Concept S.r.l.

5. SPACE SEGMENT (9/12)

Final heaters configuration and power budget

Current: **0.45 A**

Voltage: **7.2 Volt**

Power = **~4 W**

time = **300 s**

3 K

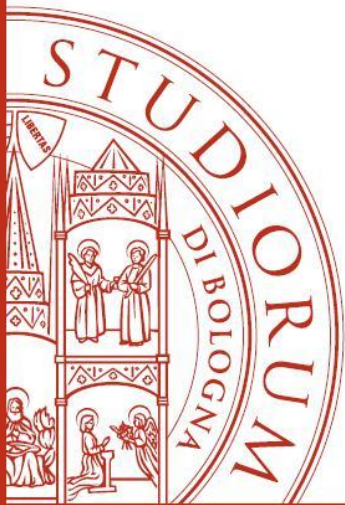

5. SPACE SEGMENT (10/12)

ADR Vacuum test

ADR architecture has been experienced in Redemption Experiment:

Vacuum test at DUNA Corradini facilities

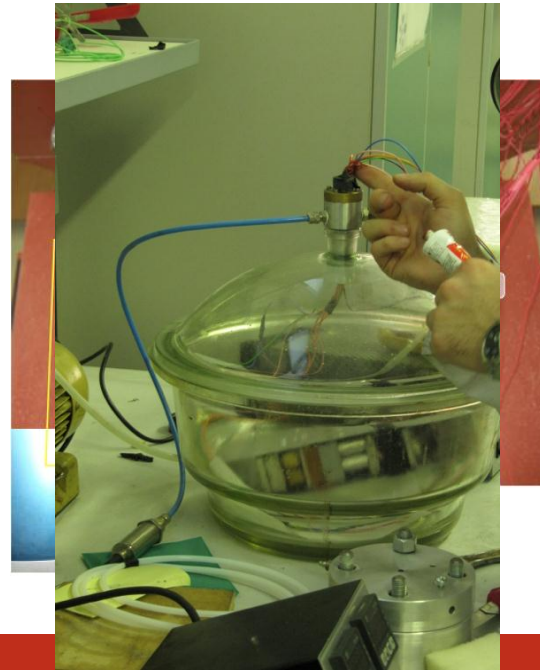
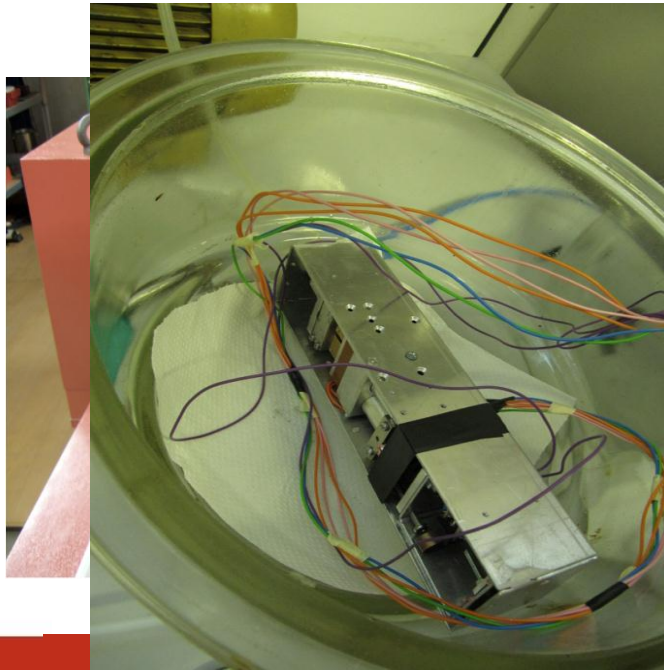
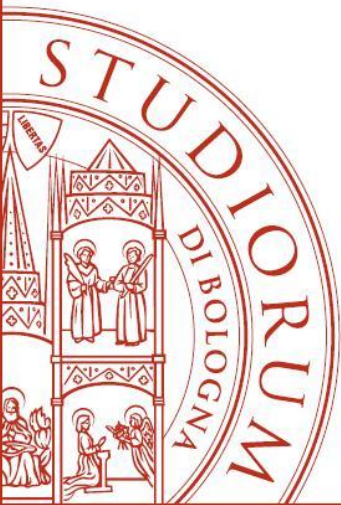

5. SPACE SEGMENT (11/12)

REDEMPTION experiment flown in the space 19 March 2012; Liftoff was from Kiruna ad ESRAN

Because some electrical problems the experiment didn't start and the rocket didn't deploy the

After the crash the ADR system was still working if activated and there was not leakg

In general the ADR system can be considered suitable for the space as survived at real rocket la

5. SPACE SEGMENT (12/12)

ABS Structure FEM analysis and vibration test:

Using electrodynamic shaker, two sinusoidal

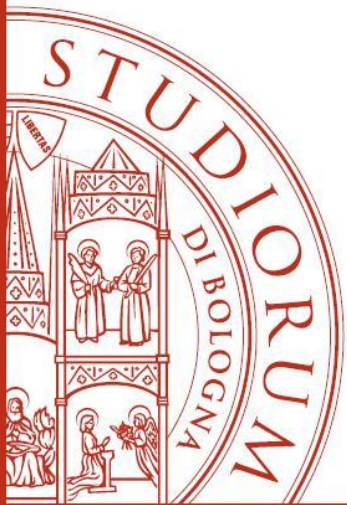

6. ORBIT DESCRIPTION (1/1)

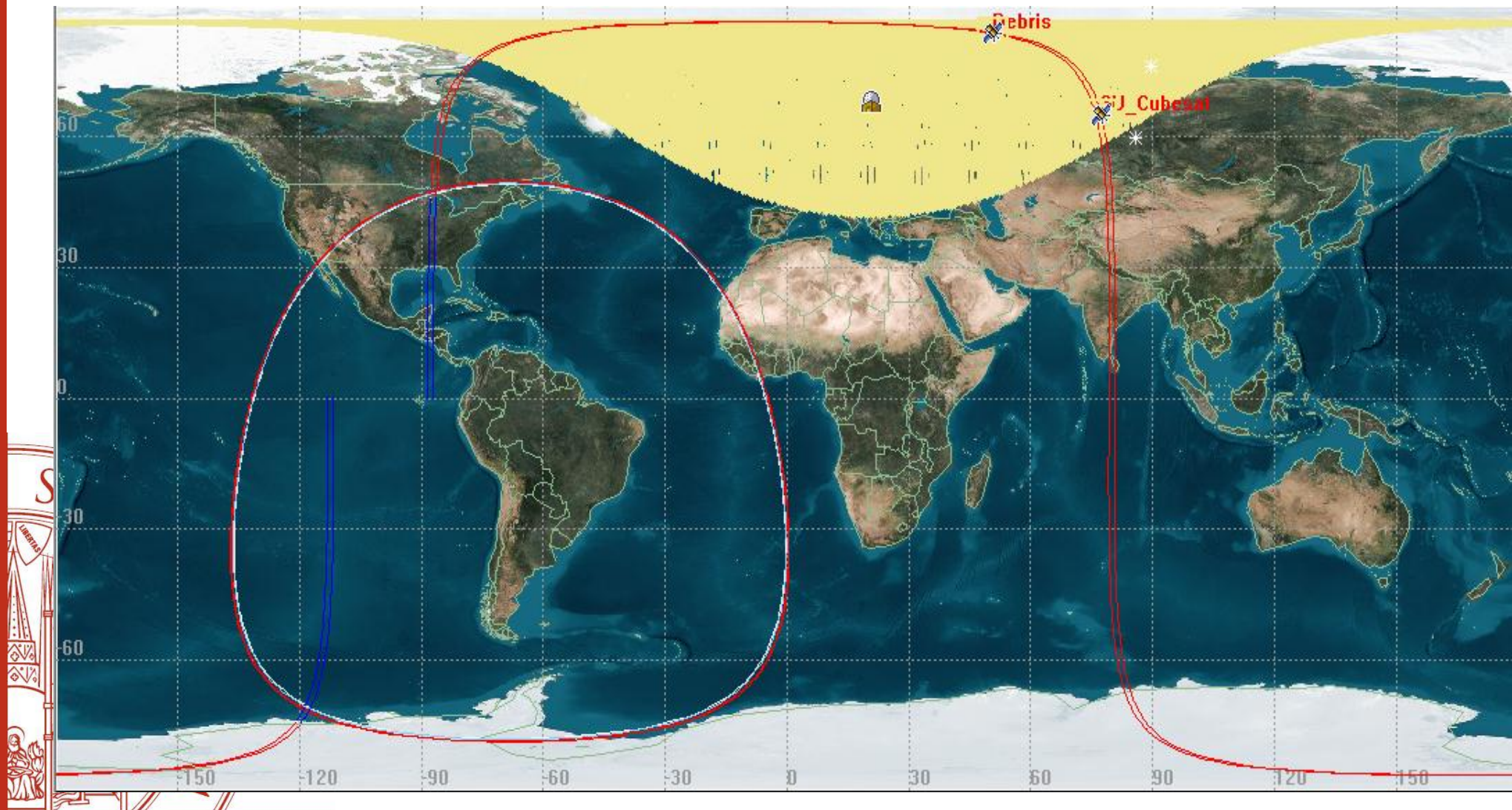

7. IMPLEMENTATION PLAN (1/2)

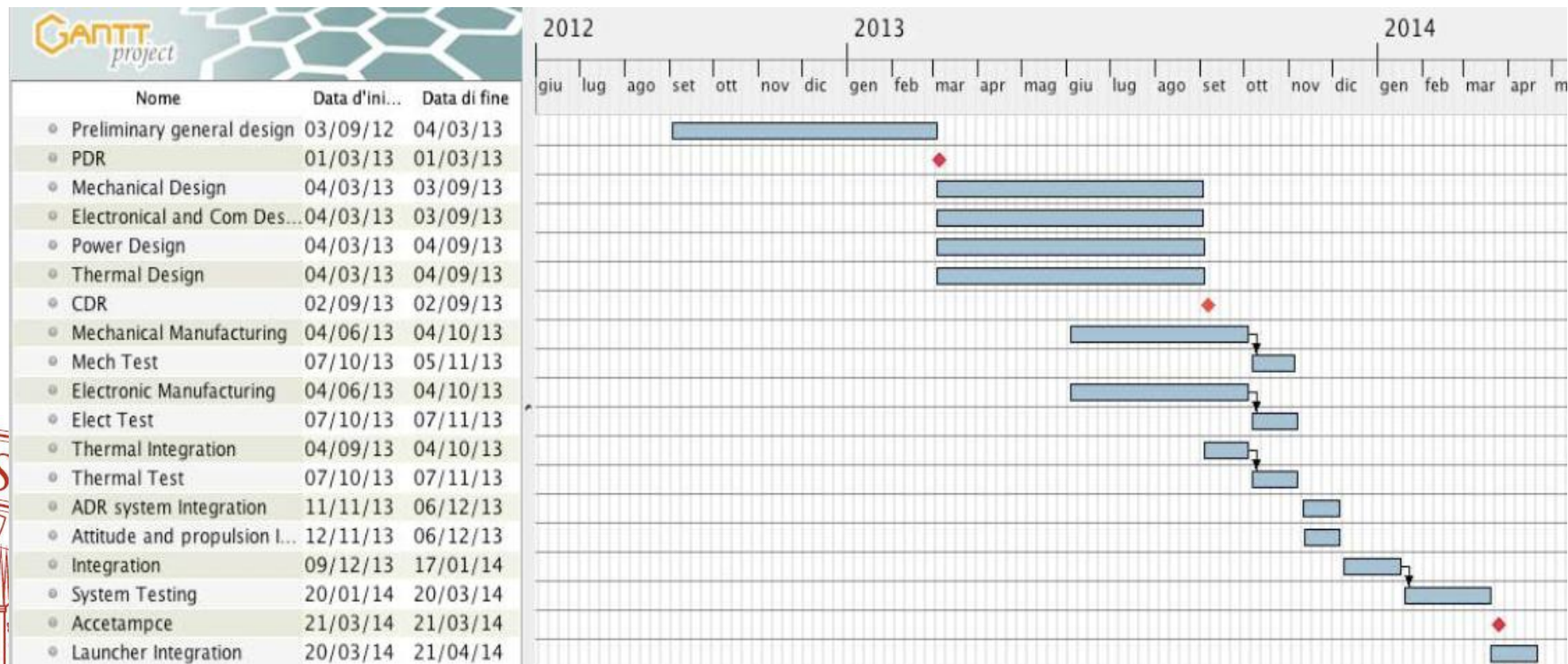

7. IMPLEMENTATION PLAN (2/2)

Risk register table

RISK	PROBABILITY	PREVENTION
Pyrocutter to open deorbiting system Failure	Very low	Double line for Power On signal and double number of Pyrocutters
Injector of ADR System failure	Very Low	Ground test in order to find the best configuration
Temperature of liquid of ADR system to low	Medium	Injection during light-day orbit period and pre heating system for fluids
ABS Structure Failure	Medium	During vibration test a safety factor of 2 will be used in addition to the value suggested by user manual of the launcher
Missing rendezvous	High	Using tested and affordable algorithm to design the system. Use of specific software for simulation

A verification matrix and tests need to be setted fo each risk in order to mitigate the risk r

In particular it must be not present hig risk before the launch

8. REFERENCES (1/1)

- [1] J-C. Liou, N.L.Johnson, N.M.Hill *Controlling the growth of future LEO debris populations*
- [2] Niccolò Bellini, *Sistema di deorbiting per nanosatelliti* , Final dissertation bachelor degree
- [3] Davide Rastelli, *Confronto tra un cubesat in ABS e un cubesat in alluminio nell'ambito*
- [4] Arianespace *VEGA User's manual Issue 3*, March 2006, Approved by Edouard Perez
- [5] Niccolò Bellini, Alfredo Locarini, Stefano Naldi, Davide Rastelli, Marcello Valdatta, *AZ1 4*
- [6] Redemption SED, G.P. Candini, J. Piattoni, F. Romei, A. Spadanuda, S. Toschi, M.
- [7] F. Piergentili, M.L. Battagliere, G.P. Candini, J. Piattoni, F. Romei, A. Spadanuda, S.
- [8] Wiley, J. Larson and James R. Wertz, *Space Mission Analysis and Design*, Third Edition,

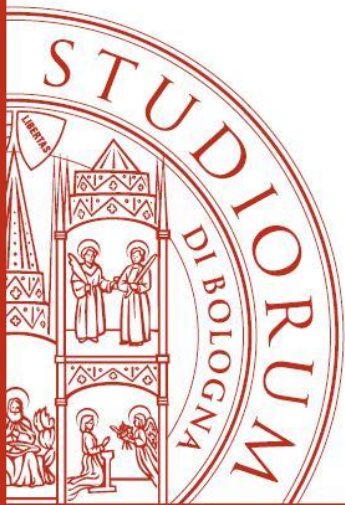

Thanks to our supporter

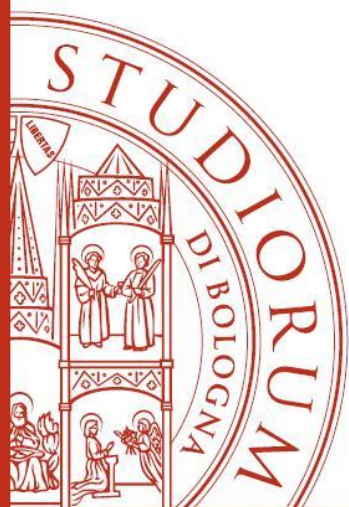

Thanks for the attention...

